



ONLINE MODE SYSTEM ADMINISTRATOR'S GUIDE

**Avery Dennison®
Monarch®
9419 Printer**

Each product and program carries a respective written warranty, the only warranty on which the customer can rely. Avery Dennison Corp. reserves the right to make changes in the product, the programs, and their availability at any time and without notice. Although Avery Dennison Corp. has made every effort to provide complete and accurate information in this manual, Avery Dennison Corp. shall not be liable for any omissions or inaccuracies. Any update will be incorporated in a later edition of this manual.

©2016 Avery Dennison Corp. All rights reserved. No part of this publication may be reproduced, transmitted, stored in a retrieval system, or translated into any language in any form by any means, without the prior written permission of Avery Dennison Corp.

Trademarks

ZPL II is a registered trademark of ZIH Corp. ZIH Corp. and Avery Dennison are not related in any way, and ZIH Corp. has not licensed or otherwise sponsored the MONARCH® or Avery Dennison printers or the MONARCH LANGUAGE INTERPRETER™.

MONARCH®, MONARCH LANGUAGE INTERPRETER, MLI, and MPCL are trademarks of Avery Dennison Retail Information Services LLC.

Avery Dennison® is a trademark of Avery Dennison Corp.



TABLE OF CONTENTS

GETTING STARTED	1-1
Audience	1-1
Using the Control Panel.....	1-1
CONFIGURING THE PRINTER	2-1
Setting the Speed	2-2
Setting the Print Contrast	2-2
Setting the Feed Mode	2-2
Setting the Supply Position	2-3
Setting the Print Position	2-3
Setting the Margin Position	2-4
Setting the Backfeed	2-4
Setting the Dispense Position	2-4
Setting the Backfeed Distance	2-5
Setting the Monetary Sign.....	2-5
Setting the Secondary Sign.....	2-6
Setting the Number of Decimal Places	2-6
Setting the Numeric Format	2-6
CONFIGURING THE MEDIA	3-1
Supply Setup Information.....	3-1
Setting the Supply Type	3-2
Calibrating the Sensor (Manual Setup).....	3-3
Sensor Locations.....	3-3
Setting the Threshold Detection	3-4
Setting the Maximum Calibration Length	3-4
Setting the Registration Length	3-4
Advanced Sensor Setup	3-5
SETTING COMMUNICATIONS	4-1
Using Serial Communications.....	4-1
Setting the Baud Rate	4-1
Setting the Parity.....	4-2
Setting the Data Bits.....	4-2
Setting the Stop Bits.....	4-2
Using Ethernet Communications	4-3
Viewing the Ethernet Settings	4-3
Configuring Ethernet Settings	4-3
Entering a Static IP Address, Subnet Mask, and Default Gateway.....	4-4
USING ADVANCED SETUP	5-1
Setting the Power-up Mode	5-2
Setting the Display Brightness	5-2
Setting the Date and Time	5-2
Setting the Language	5-3
Setting MLI Interpreter Options	5-3

USING DIAGNOSTICS	6-1
Printing a Test Label	6-1
Printing the Current Configuration	6-2
Using the Service Menu	6-3
USING THE PRINTER MANAGEMENT UTILITY.....	A-1
Configuring Ethernet Settings	A-1
Configuring WiFi Settings	A-3
Configuring the Printer	A-5
Transferring Files	A-6
MENU STRUCTURE	B-1

GETTING STARTED

The Avery Dennison® Monarch® 9419 Printer prints on thermal transfer (ribbon) and thermal direct labels or tags. The printer prints labels continuously (in one strip) or on-demand (one label at a time). You can print on die cut, black mark, or continuous (non-indexed) supplies.

The printer operates in either online or offline mode:

- | | |
|--------------|--|
| Online Mode | Use online mode when the printer receives print data from a connected host (PC or network).
This manual contains information about online mode. |
| Offline Mode | Use offline mode (stand-alone mode) when the printer receives data from a keyboard or scanner. The printer is not connected to a host. For offline mode information, refer to the <i>Offline Mode System Administrator's Guide</i> . |

Audience

This manual is for the System Administrator who configures and updates the printer.

- ◆ To load supplies, print labels, or care for the printer, refer to the *Equipment Manual*.
- ◆ To create format and batch packets for printing or how to configure the printer online, refer to the *Packet Reference Manual*.

Use the Printer Management Utility to transfer files to the printer and configure the printer. See Appendix A, "[Using the Printer Management Utility](#)" for more information.

Using the Control Panel

The control panel has an LCD display with two function buttons and a navigation button.

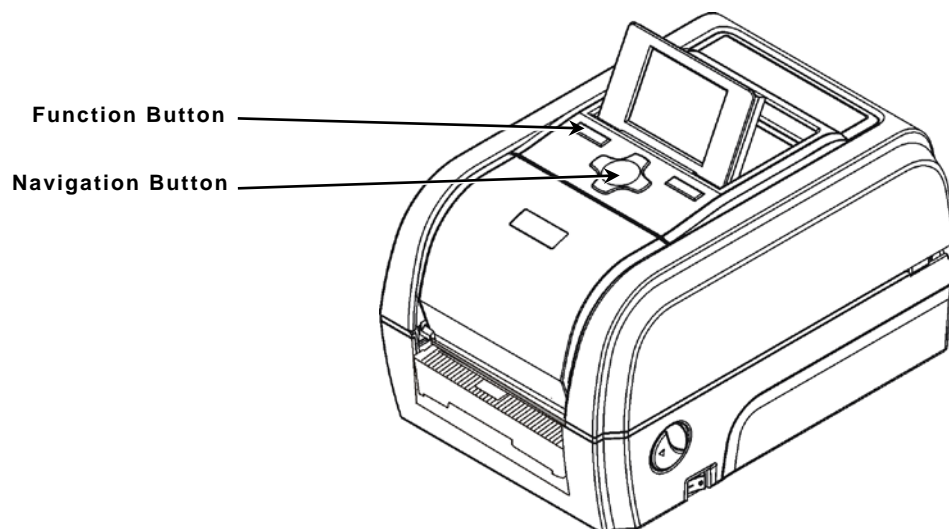

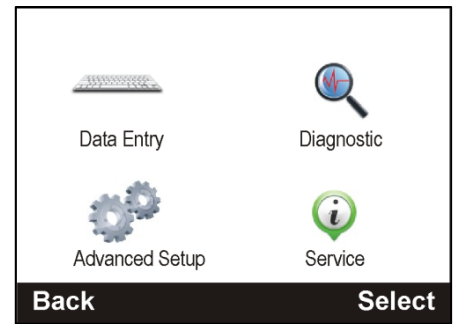
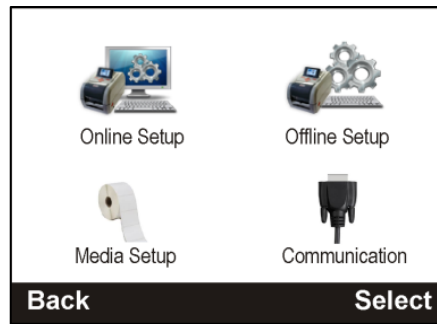
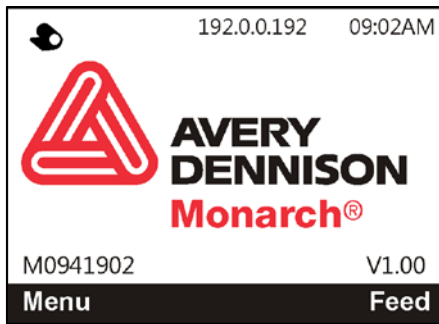

Menu Item	Description
Online Setup	Configuring the printer for use while connected to a host. See Chapter 2 " Configuring the Printer " for more information.
Offline Setup	Configuring the printer for use in offline mode. Refer to the <i>Offline Mode System Administrator's Guide</i> .
Media Setup	Configuring the supply type and calibrating the sensors. See Chapter 3, " Configuring the Media " for more information.
Communication	Setting up serial or Ethernet communications. See Chapter 4, " Setting Communications " for more information.
Data Entry	Select and enter data for pre-loaded formats. Refer to the <i>Offline Mode System Administrator's Guide</i> .
Advanced Setup	System settings such as date and time, display brightness, etc. See Chapter 5, " Using Advanced Setup " for more information.
Diagnostic	Printing a test label or the printer's configuration, viewing printer information, etc. See Chapter 6, " Using Diagnostics " for more information.
Service	Contains Service information, which requires a separate password to access.

CONFIGURING THE PRINTER

This chapter explains how to select the speed, contrast, feed mode, supply position, print position, margin position, backfeed, dispense position, backfeed distance, monetary sign, secondary sign, decimal places, and numeric format.



The online setup options are listed in the table below.

Option	Choices	Default
Speed	1.5/2/3/4/5/6/7/8	5
Contrast	-156 to 156	0
Feed Mode	Continuous/On-Demand	Continuous
Supply Position	-149 to 300 dots (203 dpi) or -222 to 300 dots (300 dpi)	0
Print Position	-99 to 99 dots	0
Margin Position	-99 to 99 dots	0
Backfeed	Enable/Disable	Enable
Dispense Position	10 to 200 dots	65
Backfeed Distance	10 to 200 dots	65
Monetary Sign	No symbol, Euro, Chinese, Thai, Korean, Russian, India, Austria, Finland, Sweden, Italy, Spain, France, Germany, Japan, UK, USA	USA
Secondary Sign	No/Print	No
Decimal Places	None/One Digit/Two Digits/Three Digits	Two Digits
Numeric Format	Standard Zero/Slashed Zero	Standard Zero

Setting the Speed

Select the print speed in IPS (inches per second). If print quality is important, reduce the print speed - a lower print speed increases the print quality of labels. Use premium supplies when printing at high speeds. The default setting is 5.

Select	To
1.5	Print at 1.5 IPS.
2	Print at 2.0 IPS.
3	Print at 3.0 IPS.
4	Print at 4.0 IPS.
5	Print at 5.0 IPS.
6	Print at 6.0 IPS.
7	Print at 7.0 IPS.
8	Print at 8.0 IPS.

Note: The maximum speed using a 300 dpi printhead is 6.0 ips.
The maximum speed using peel mode is 3.0 ips.

Setting the Print Contrast

Having the correct print contrast/density setting is important because it affects bar code scan ability and printhead life. The default is 0.

Solid black print cannot exceed 30% of any given square inch of the supply.

Select	To
Navigation button: ← or →	Selects positive or negative and which position to change.
Navigation button: ↑ or ↓	Increase or decrease the contrast to darken or lighten the print.

Setting the Feed Mode

Set the feed mode based on your application and supply type. The default is continuous.

Select	To
Continuous	Print all tags or labels in a batch (job) in one strip.
On-Demand	Print one label, once that label is removed, the next label prints.

Setting the Supply Position

This function adjusts the position of the supply relative to the index marks in the feed direction. Adjust the supply position to compensate for supply variation. The adjustments are in dots where one dot equals 0.0049 inch. The default is 0.

Select	To
Navigation button: ← or →	Selects positive or negative and which position to change.
Navigation button: ↑ or ↓	Increase or decrease the supply position to move the print up or down.

Setting the Print Position

This function adjusts the image's position on the supply in the feed direction. Adjust the print position if the print is too close to the top or bottom of the supply, or overtypes the pre-printed area. The adjustments are in dots where one dot equals 0.0049 inch. The default is 0.

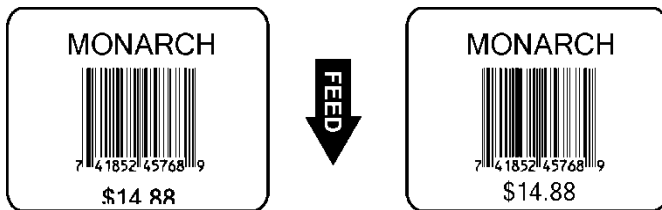

Select	To
Navigation button: ← or →	Selects positive or negative and which position to change.
Navigation button: ↑ or ↓	Increase or decrease the print position to move the print up or down.

Setting the Margin Position

This function adjusts where the format prints side to side on the supply. The adjustments are in dots where one dot equals 0.0049 inch. The default is 0.



Print too far to the left



Print too far to the right

Select

To

Navigation
button: ← or →

Selects positive or negative and which position to change.

Navigation
button: ↑ or ↓

Increase or decrease the margin position to move the print left or right.

Setting the Backfeed

Backfeed advances each printed label to the desired dispense position. Once that label is removed, the next label to be printed is backed up underneath the printhead. The default is enable.

Select

To

Disable

Disable backfeed.

Enable

Enable backfeed. The printer moves the supply backwards before printing.

Setting the Dispense Position

This function adjusts the amount to advance each label to allow for easy removal from the printer. The default is 65.

Select

To

Navigation
button: ← or →

Selects positive or negative and which position to change.

Navigation
button: ↑ or ↓

Increase or decrease the margin position to move the print left or right.

Setting the Backfeed Distance

The function adjusts the amount to move the label backwards at the start of each batch (or label in on-demand mode). The backfeed distance should be equal to or less than the dispense position. If the backfeed distance is greater than the dispense position, the dispense position automatically changes to match the backfeed distance. The default is 65.

Select	To
Navigation button: ← or →	Selects positive or negative and which position to change.
Navigation button: ↑ or ↓	Increase or decrease the margin position to move the print left or right.

Setting the Monetary Sign

The printer contains 16 different currency symbols. The default is USA.

Select	To
None	Does not print a monetary sign.
Euro	Print the € sign.
Chinese	Print the ¥ sign.
Thai	Print the ฿ sign.
Korean	Print the ₩ sign.
Russian	Print the ₺ sign.
India	Print the Rs sign.
Austria	Print the ₳ sign.
Finland	Print the ₯ sign.
Sweden	Print the Kr sign.
Italy	Print the L. sign.
Spain	Print the P sign.
France	Print the F sign.
Germany	Print the ₧ sign.
Japan	Print the ¥ sign.
UK	Print the £ sign.
USA	Print the \$ sign.

Setting the Secondary Sign

If you select the dollar as the monetary sign, you can print amounts less than \$1.00 either by using a dollar sign and decimal (\$0.30) or by using a cent sign (30¢). The default is No.

Select	To
No	Do not print a secondary monetary sign. prices under \$1.00 will print like this: \$.45
Yes	Print a secondary monetary sign. prices under \$1.00 will print like this: 45¢

Note: The same option applies to the appropriate secondary sign for monetary signs other than the dollar.

Setting the Number of Decimal Places

you might print prices like this: \$24.00 (2 decimal places) or like this: \$24 (0 decimal places). The default is Two Digits.

Select	To
None	Do not use decimal places. prices print as whole numbers: \$20
One Digit	Print one place after the decimal. prices print like this: \$20.5
Two Digits	Print two places after the decimal. prices print like this: \$20.50
Three Digits	Print three places after the decimal. prices print like this: \$20.500

Setting the Numeric Format

The numeric format sets how the zero character prints; either without a slash, 0 or, with a slash, Ø. The default is Standard Zero.

Select	To
Standard Zero	Do not print zeroes with a slash.
Slash Zero	Prints zeroes with a slash (Ø).

CONFIGURING THE MEDIA

This chapter explains how to select the supply type and manually calibrate the sensors.



The media setup options are listed in the table below.

Option	Choices	Default
Supply Type	Gap/Black Mark/Continuous	Gap
Manual Setup	Gap/Black Mark/Continuous	NA
Threshold Detect	Auto/Fixed	Auto
Maximum Length	1 to 10.0 inches (25mm to 254mm)	253 mm
Advanced	On/Off	OFF

Supply Setup Information

- ◆ When using die cut 4x6 supplies, no calibration is required. The printer calibrates automatically when supply is loaded and the user presses **Feed**.
- ◆ When using pre-printed supply or tinted supply, manually calibrate the sensor.

Setting the Supply Type

Set the printer's supply type to match the loaded supplies.

Note: The printer automatically calibrates the sensor based on the selected supply type.

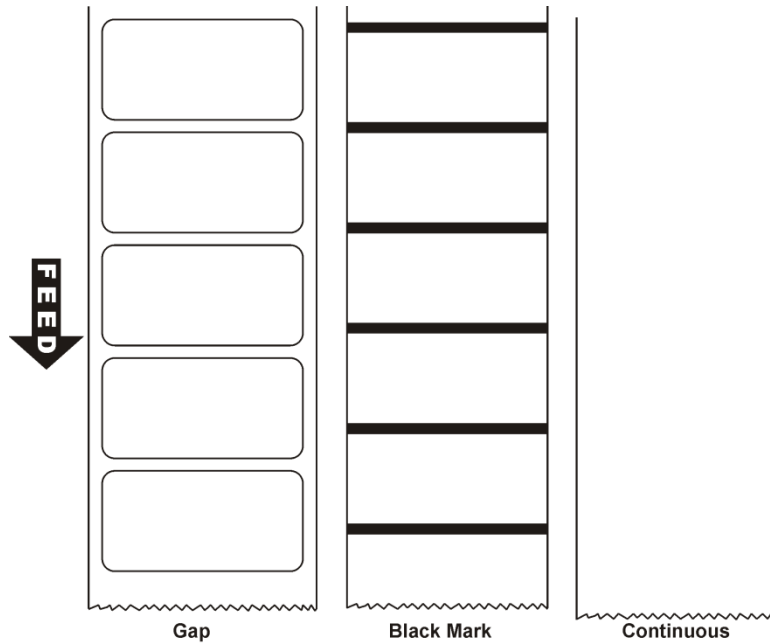

Select	For
Gap	Die cut supplies have a rounded edge. The supply is sensed using the gap between labels.
Black Mark	Black marks on the back of the supply for sensing. The supply is sensed using the black marks. Tag supply commonly uses black marks.
Continuous	Continuous supply does not have any index marks for sensing or perforations.

Calibrating the Sensor (Manual Setup)

When using pre-printed or tinted supply, manually calibrate the sensor.

- | Select | For |
|---------------|---|
| Gap | Calibrate die cut supply:
Follow instructions on screen to place backing paper over the die cut sensor. Close the cover. Press Select . Then, place label over the sensor, close the cover and press Select . A message appears with intensity and threshold readings when successful. If not, recalibrate. |
| Black Mark | Calibrate black mark supply:
Follow instructions on screen to place a black mark over the black mark sensor. Close the cover. Press Select . Then, place label or tag (not black mark) over the sensor, close the cover and press Select . A message appears with intensity and threshold readings when successful. If not, recalibrate. |
| Continuous | Calibrate continuous supply:
Follow instructions on screen to <i>remove supply</i> from the printer. Close the cover. Press Select . Then, place label or tag in the printer, close the cover and press Select . A message appears with intensity and threshold readings when successful. If not, recalibrate. |

Sensor Locations

Note the location of the die cut and black mark sensor:

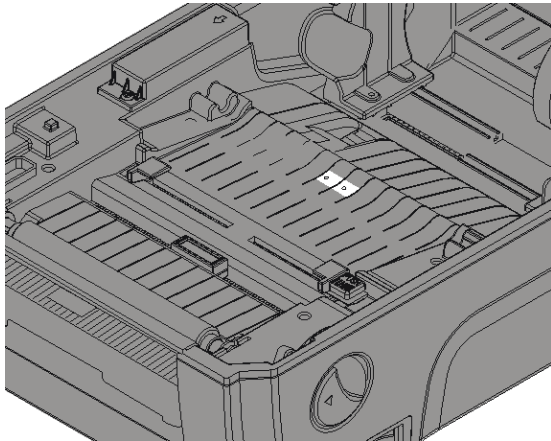

Die Cut Sensor

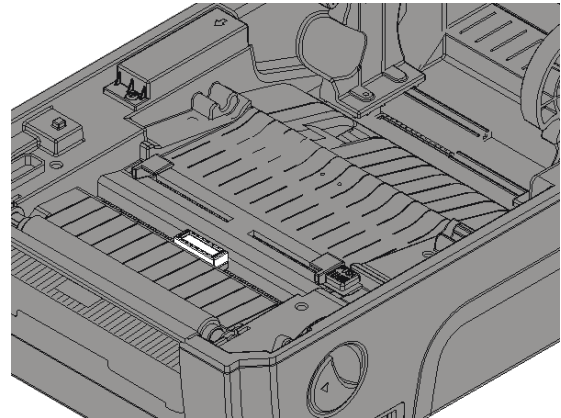

Black Mark Sensor

Setting the Threshold Detection

Set the sensor's threshold detection.

Select	For
Auto	Use for plain white supply.
Fixed	Use for pre-printed or tinted supply.

Setting the Maximum Calibration Length

If you experience frequent supply errors, calibrate the maximum supply length. This value is entered in millimeters. The default is 253 mm (10 inches).

Select	To
Navigation button: ← or →	Selects positive or negative and which position to change.
Navigation button: ↑ or ↓	Increase or decrease the maximum calibration length.

Setting the Registration Length

The registration length is available using version 2.1 or greater firmware.

Enable or disable the registration length to control how the printer calibrates and/or tries to print formats when the format size differs from the loaded supply length.

Select	For
On	<p>Prints formats according to the length specified in the <i>format header</i>. Refer to the <i>Packet Reference Manual</i> for more information about creating formats. The loaded supply length must match the length in the format header or an error occurs.</p> <p>This is helpful when using one supply size, because the printer calibrates to a specific format. For example, your supply is four-inches long and a four-inch format is received by the printer. The printer prints the entire format and calibrates to four inches.</p>
Off	<p>Prints formats without reading the length from the format header. This is the default mode, which ensures compatibility with previous versions of firmware.</p> <p>The printer calibrates by looking for sense marks on the supply. It prints the data that fits on the loaded supply. For example, your supply is 2.0-inches long, but a four-inch long format is received by the printer. The printer prints only the first two inches of the format and does not error.</p> <p>This is helpful when using multiple supply sizes and multiple formats.</p>

Note: Operators should calibrate supply whenever changing the supply type or the supply size.

Advanced Sensor Setup

If you experience frequent supply errors, set the minimum supply length and the maximum gap/black mark. This value is entered in millimeters. The default is OFF.

Select	For
On	To set the minimum supply length and the maximum gap or black mark length for the sensor's auto calibration. Press Select . Use the navigation button to scroll to set the Min. Paper (minimum supply length in mm) and Max. Gap/Mark (maximum gap or black mark length).
Off	Do not set the minimum supply length and the maximum gap or black mark length for the sensor's auto calibration.

This chapter tells you how to set the serial and Ethernet communication values. These values provide the link for normal online printing.

The communication settings at the printer must match the host's communication values.

Using Serial Communications



The serial communication values are in the table below.

Option	Choices	Default
Baud rate	1200/2400/4800/9600/19200/38400/57600/115200	9600 bps
Parity	None/Even/Odd	None
Data Bits	7/8	8
Stop bits	1/2	1

Note: The serial values on the printer must match those at the host.

Setting the Baud Rate

Baud rate is the speed, in bps (bits per second), at which the printer sends and receives data. The default is 9600 bps.

Select	To
1200	Communicate at 1200 bits per second.
2400	Communicate at 2400 bits per second.
4800	Communicate at 4800 bits per second.
9600	Communicate at 9600 bits per second.
19200	Communicate at 19200 bits per second.
38400	Communicate at 38400 bits per second.
57600	Communicate at 57600 bits per second.
115200	Communicate at 115200 bits per second.

Setting the Parity

Parity checks the validity of data entering the printer. The parity bit immediately follows the last data bit for a character. The parity bit is adjusted according to the parity so the data bits in the character, with the parity bit, form an odd or even number when summed.

Select	To
None	Set the parity to none (no parity check).
Odd	Set the parity to odd.
Even	Set the parity to even.

Setting the Data Bits

Data bits specifies how many bits the printer uses to define a character.

Select	To
7	Set the word length to seven.
8	Set the word length to eight.

Setting the Stop Bits

A stop bit follows the data and parity bits to signal the end of a character.

Select	To
1	Set the stop bit length to one.
2	Set the stop bit length to two.

Using Ethernet Communications

The printer communicates on a 10baseT or 100baseTX wired Ethernet connection.

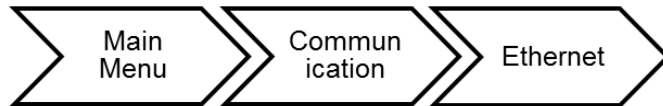

The Ethernet options are listed in the table below.

Option	Choices	Default
Status	View only	None – view only
Configure	DHCP/Static IP	DHCP

Use the Printer Management Utility to configure the Ethernet settings. See “[Configuring Ethernet Settings](#)” for more information

Viewing the Ethernet Settings

Select Status from the Ethernet menu to view the current Ethernet settings.

The viewable Ethernet settings include MAC Address, IP Address, Subnet Mask, and Default Gateway. The Media Access Control (MAC) Address is a hard-coded value that cannot be changed (like a serial number).

Configuring Ethernet Settings

1. Select Configure from the Ethernet menu to change the Ethernet settings.
2. Select either DHCP or Static:

Static Use if your network uses a fixed configuration. The IP address remains the same every time the device connects to the network. For static, you must set an IP Address, Subnet Mask, and Default Gateway. See “[Entering a Static IP Address, Subnet Mask and Default Gateway](#)” for more information.

DHCP The network automatically assigns an IP address within a specified range to a device when it is first turned on. A device could have a different IP address every time it connects to the network.

3. Select **Yes** to save the DHCP setting. The printer reboots and establishes a connection. Or, press **No** to exit without saving.

Entering a Static IP Address, Subnet Mask, and Default Gateway

The IP (Internet Protocol) address is a unique identifier for a device on a network. It consists of four 3-digit numeric fields, separated by periods.

IP networks are divided using subnet masks. The subnet mask address determines where the IP address belongs in the network. It consists of four 3-digit numeric fields.

The default gateway (or router) allows connections (communications) between different subnets on a network. It consists of four 3-digit numeric fields.

To set the *static* IP Address, Subnet Mask and Default Gateway:

1. Use the buttons as shown below:

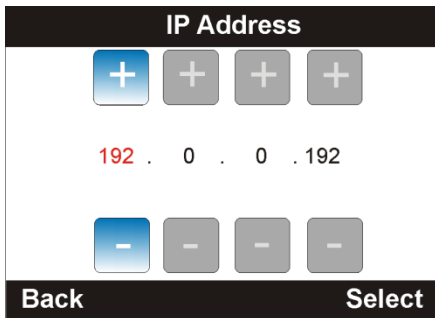

Select

Navigation button: ← or →

Navigation button: ↑ or ↓

To

Selects which position to change.

Increase or decrease the number.

2. Press **Select** when finished entering the IP Address, Subnet Mask, and Default Gateway.
3. Press **Yes** to save the settings. The printer reboots and establishes a connection. Or, press **No** to exit without saving.

USING ADVANCED SETUP

This chapter explains how to select the power-up mode, display brightness, date, time, language, and MLI interpreter options.



The advanced setup options are listed in the table below.

Option	Choices	Default
Power-up Mode	Online/Offline	Online
Display Brightness	0 to 100	50
Date & Time	Date Time	
Language	English, Traditional Chinese, Simplified Chinese, Japanese, Korean, German, Dutch, French, Italian, Spanish, Portuguese, Swedish, Norwegian, Danish, Finnish, Polish, Czech, Slovak, Hungarian, Slovenian, Croatian, Russian, Ukrainian, Bulgarian, Kazakh, Greek, Turkish, Lithuanian, Canadian French, Latin American Spanish, and Brazilian Portuguese	English
MLI Interpreter	See " Setting MLI Interpreter Options " for more information.	N/A

Setting the Power-up Mode

Power-up mode lets you decide how your printer starts each time you turn it on. The default is online.

- ◆ Ready to receive data and start printing (online mode).
- ◆ Operator can select a format to print (offline mode).
- ◆ Operator can enter data for a selected format using the optional keyboard.

Select	To
--------	----

Online	When the printer is turned on, you see the main screen.
--------	---

Offline	When the printer is turned on, you see Data Entry mode. Make sure formats are loaded and a keyboard is connected if you need to enter data. Press Back , then Menu and Advanced Setup to change this mode.
---------	---

Setting the Display Brightness

Adjust the screen's brightness for better visibility. The default is 50.

Select	To
--------	----

Navigation button: ↑ or ↓	Increase or decrease the screen's brightness for better visibility.
---	---

Setting the Date and Time

The printer contains a real-time clock. Set the clock during initial printer setup. The printer keeps track of the date and time even when the printer is turned off. The clock does not adjust for daylight saving time.

Select	To
--------	----

Navigation button: ← or →	Select which position to change.
---	----------------------------------

Year, Month, Day

Hours, Minutes, Seconds

Note: The clock operates on 24-hour time. For example, setting the hours to 16 indicates 4:00 PM.

Navigation button: ↑ or ↓	Increase or decrease the date and time as needed.
---	---

Setting the Language

The printer can display prompts in different languages:

English, 繁體中文 (Traditional Chinese), 简体中文 (Simplified Chinese), 日本語 (Japanese), 한국어 (Korean), Deutsch (German), Nederlands (Dutch), Français (French), Italiano (Italian), Español (Spanish), Português (European Portuguese), Svenska (Swedish), Norsk (Norwegian), Dansk (Danish), Suomi (Finnish), Polski (Polish), Čeština (Czech), Slovenčina (Slovak), Magyar (Hungarian), Slovenščina (Slovenian), Hrvatski (Croatian), Русский (Russian), Український (Ukrainian), български (Bulgarian), Қазақша (Kazakh), Ελληνικά (Greek), Türkçe (Turkish), Lietuvių (Lithuanian), Français du Canada (Canadian French), Español (Latin American Spanish), and Português Brasil (Brazilian Portuguese).

Note: Some prompts may remain in English, even if you select a different language.

Setting MLI Interpreter Options

Avery Dennison's MONARCH LANGUAGE INTERPRETER™ (MLI™) and the Avery Dennison 9419 printer are set up for use with ZIH Corp.'s ZPL II®. If you have any questions about using the 9419 printer with these data streams, please contact your Avery Dennison representative.

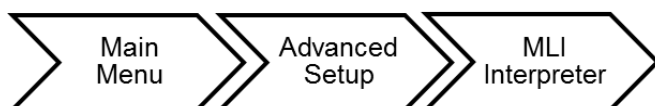

The MLI interpreter options are listed in the table below.

Option	Choices/Description	Default
Darkness	0 to 30 Adjusts darkness of print	16
Print Speed	2 to 6 Sets the print speed	4 ips
Tear Off	+/- 0 to 9 Sets the media stopping point for easy tear off	0 dot
Print Mode	Tear Off/Peeler Off/Cutter	Tear Off
Print Width	0 to 9 Sets the print width	812 dot
List Fonts	Prints list of printer fonts	NA
List Images	Prints list of printer images	NA
List Formats	Prints list of printer formats	NA
List Setup	Prints current printer configuration	NA

Option	Choices/Description	Default
Control Prefix	Sets control prefix character	7E ~
Format Prefix	Sets format prefix character	5E ^
Delimiter Char	Sets the delimiter character	2C ,
Media Power Up	Feed/Calibration/Length/ No Motion Sets media action	No Motion
Head Close	Feed/Calibration/Length/ No Motion Sets media action when printhead is closed	No Motion
Label Top	-120 to 120 adjusts print position vertically	0 dot
Left Position	-9999 to 9999 adjusts print position horizontally	0
Reprint Mode	Enable/Disable Reprint last label by pressing ↑ “up” button	Disable
Format Convert	Sets bitmap scaling factor in dpi; first number is the original dpi; second number is desired dpi	None

USING DIAGNOSTICS

This chapter explains how to print a test label and the printer's configuration and view the printer's information.



The Diagnostic options are listed in the table below.

Option	Choices
Test Label	NA
Print Config	NA
Printer Information	View the printer's serial number, mileage (meters printed), labels printed, and the number of cuts.
Contact Us	View our Web site address.

Printing a Test Label

The test labels represent the printer's ONLINE mode settings.

From the Main Menu select **Diagnostic**, then **Test Label**. Three test labels print:

Printer Information

Contains generic information, including speed, contrast, and inch counts.

MONARCH

```

MODEL: M0941902 F/W: Version 1.0
COM      : 9600,N,8,1
SPEED    : 5/sec
CONTRAST : 0
MPCL     : {,"}
GAP SENSOR* : 11 REFLECTIVE : 8
LABEL LENGTH : 223
TOTAL INCHES : 485
  
```



MPCL Label

Contains the printer's MPCL packet configuration. Refer to the *Packet Reference Manual* for more information.

MONARCH

```

MODEL: M0941902 F/W: Version 1.0
A,0,0,0,0,0;
B,1,0,0,0,0;
C,0,0,0,50,0,0;
D,1,0,2;
E,{,},,},~,^,_,-,0d/0a;
F,3,1,0,0,1;
  
```



Network Configuration

Contains the printer's network/Ethernet configuration.

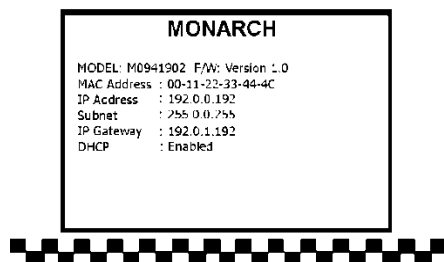

Printing the Current Configuration

The printed labels represent printer's OFFLINE mode settings and configuration.

```
-----
      SYSTEM INFORMATION
-----
MODEL:    M0941902
FIRMWARE: 4.06 MLI
CHECKSUM: 0C344522
S/N:      TX215310078
TCF:      NO
DATE:     2016/05/13
TIME:     09:15:03
NON-RESET: 6 m (TPH)
RESET:    6 m (TPH)
NON-RESET: 0 m (CUT)
RESET:    0 m (CUT)
-----
      PRINTING SETTING
-----
SPEED:    2 IPS
DENSITY:  8.0
WIDTH:    4.00 INCH
HEIGHT:   2.00 INCH
GAP:      0.14 INCH
INTENSION: 10
CODEPAGE: 850
COUNTRY:  001
-----
      Z SETTING
-----
DARKNESS: 16.0
SPEED:    4 IPS
WIDTH:    4.00 INCH
TILDE:    7EH (~)
CARET:    5EH (^)
DELIMITER: 2CH (,)
POWER UP: NO MOTION
HEAD CLOSE: NO MOTION
-----
      RS232 SETTING
-----
BAUD:     9600
PARITY:   NONE
DATA BIT: 8
STOP BIT: 1
-----
```

```

-----
ETHERNET SETTING
-----
NAME: PRINTER1
MAC ADDR: 001B82-8001AB
DHCP: ON
IP ADDR: 192.0.192.0
SUBNET: 255.255.0.0
GATEWAY: 192.0.0.0
PORT: 9100
-----

WLAN SETTING
-----
MAC ADDR: 00-00-00-00-00-00-00
WIFI REGION: US
MODE: INFRASTRUCTURE
SSID:
DHCP: OFF
IP ADDR: 0.0.0.0
SUBNET: 0.0.0.0
GATEWAY: 0.0.0.0
PORT: 0
-----

DRAM FILE (0 FILES)
-----
PHYSICAL 128 MBYTES
AVAILABLE 8192 KBYTES
-----

FLASH FILE (2 FILES)
-----
LABEL_01 183 BYTES
LABEL_02 259 BYTES
PHYSICAL 128 MBYTES
AVAILABLE 80758 KBYTES
-----

SYSTEM FILE (3 FILES)
TEST.CSV 2421 BYTES
SAMPLE01.BAS 1292 BYTES
SAMPLE02.BAS 1495 BYTES
-----

```

Using the Service Menu

The Service Diagnostics menu can only be accessed by a Service Representative; it requires a separate password.



USING THE PRINTER MANAGEMENT UTILITY

Download the Printer Management Utility from our Web site. Use the Printer Management Utility to

- ◆ change basic or advanced printer settings, including changing the print speed or code page.
- ◆ set the printer's clock (year, date and time).
- ◆ send commands
- ◆ print test or configuration pages
- ◆ reset or calibrate the printer.
- ◆ download fonts to the printer.

Configuring Ethernet Settings

Configure Ethernet settings with the Printer Management Utility:

1. Connect the printer to your computer and turn on the printer.
2. Double click on the Printer Management Utility icon to open it. The main screen shows a list of printers connected to the computer.

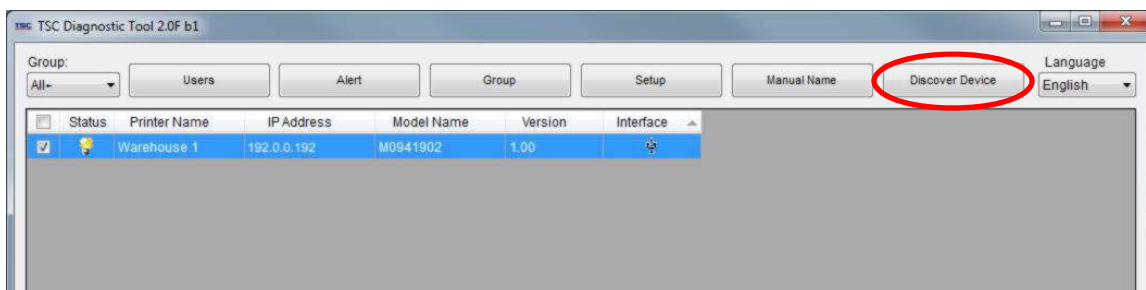

3. Click **Discover Device** to show printer(s) on the network via Ethernet.

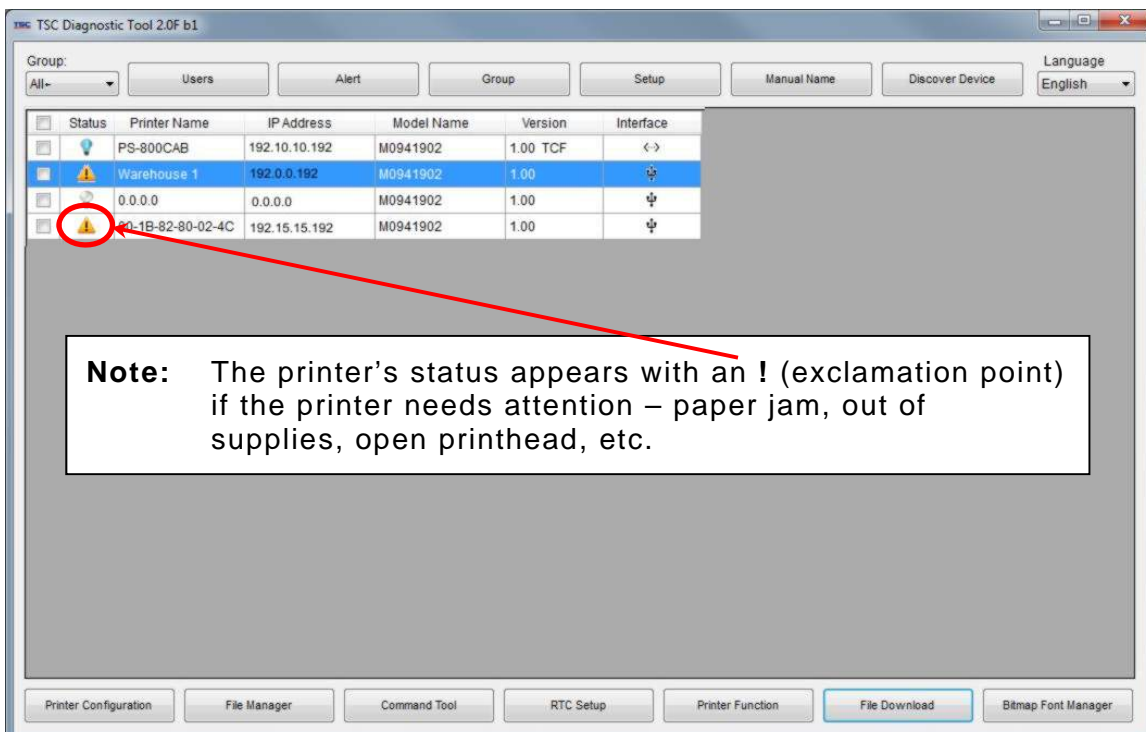

4. Select a printer to configure.
5. Click **Printer Configuration**.
6. Click **Ethernet** then press **Feed** on the printer.

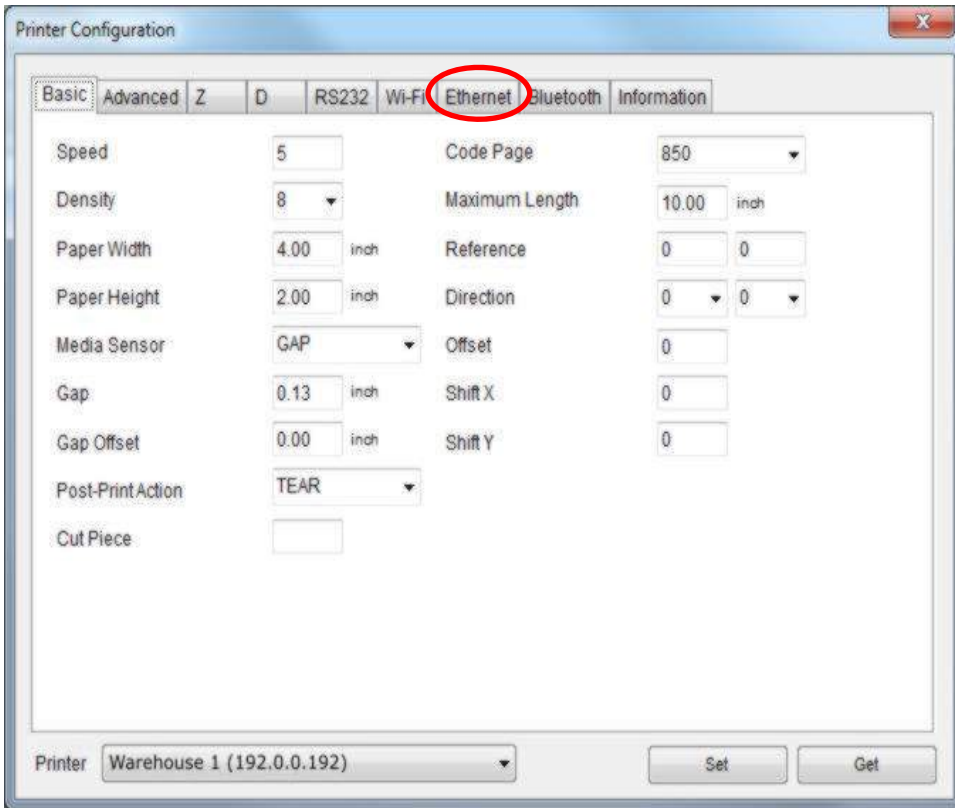

7. Select Static or DHCP. For Static, enter the IP, Subnet Mask, and Default Gateway.

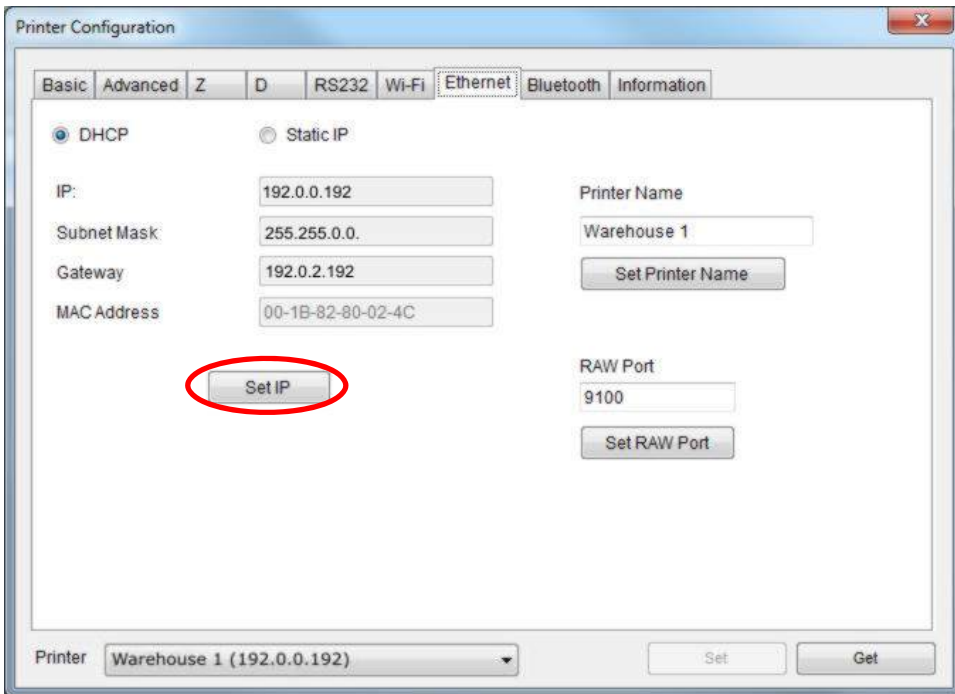

8. Press **Set IP** when finished. The printer reboots and establishes a connection.

Configuring WiFi Settings

A web browser is also available to configure WiFi. Enter the printer's IP address into a Web browser. The website appears for the *Wifi card's* manufacturer. Enter the network specific information for SSID, Encryption, etc.

To configure WiFi using the Printer Management Utility:

1. Connect the printer to your computer and turn on the printer.
2. Double click on the Printer Management Utility icon to open it.
The main screen shows a list of printers connected to the computer.
3. Select a printer to configure.
4. Click **Printer Configuration**.
5. Click **Wi-Fi**.

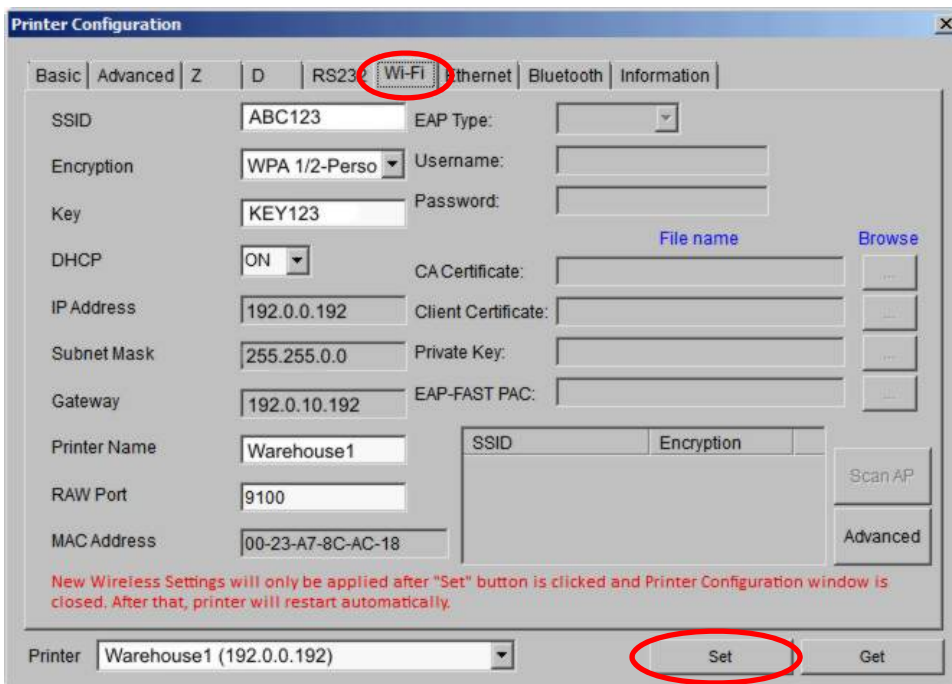
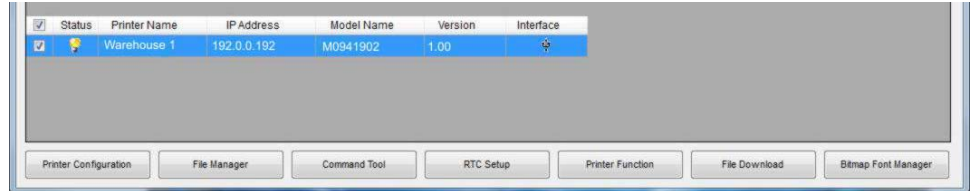

6. Enter your network specific information for SSID, Encryption, etc.
7. Press **Set** when finished. The printer reboots and establishes a wireless connection.
8. Close the Printer Configuration window. The printer reboots and establishes a wireless connection.

Configuring the Printer

1. From the main Printer Management Utility screen, click **Printer Configuration**.

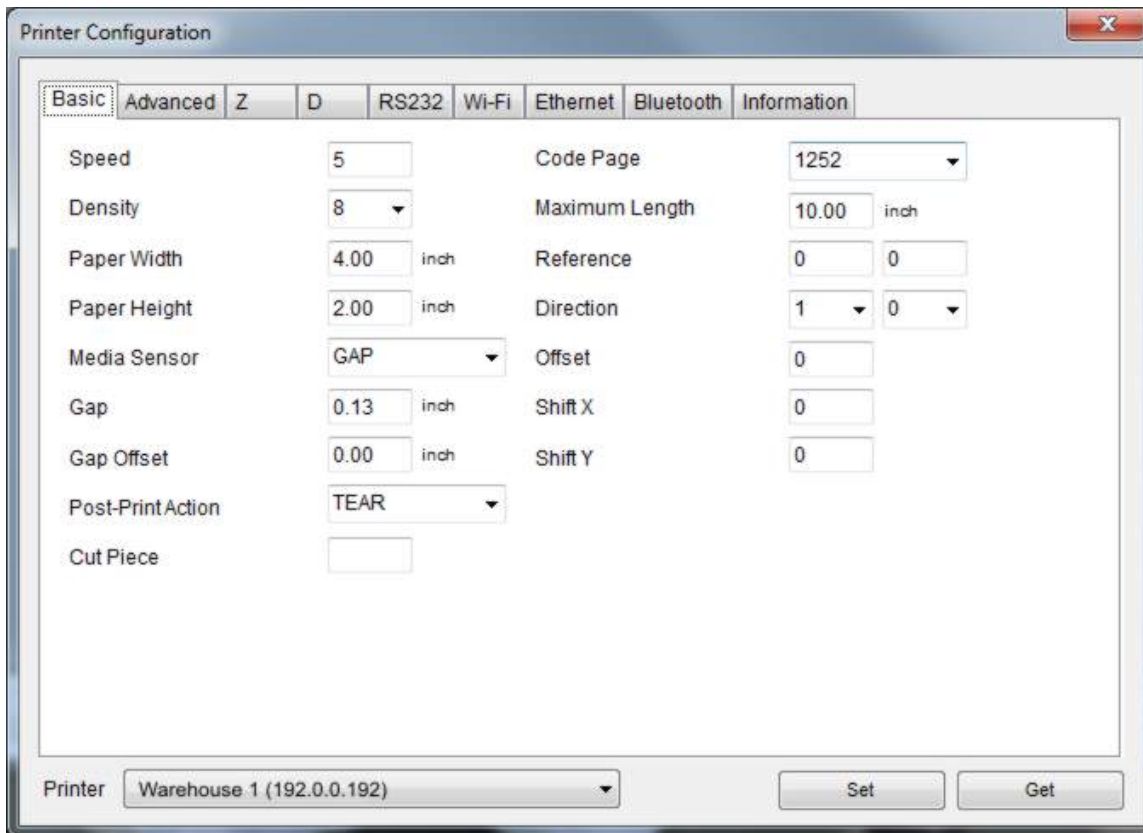

The screenshot shows the 'Printer Configuration' dialog box with the 'Basic' tab selected. The settings are as follows:

Parameter	Value
Speed	5
Density	8
Paper Width	4.00 inch
Paper Height	2.00 inch
Media Sensor	GAP
Gap	0.13 inch
Gap Offset	0.00 inch
Post-Print Action	TEAR
Cut Piece	<input type="checkbox"/>
Code Page	1252
Maximum Length	10.00 inch
Reference	0 0
Direction	1 0
Offset	0
Shift X	0
Shift Y	0

Printer: Warehouse 1 (192.0.0.192)

Buttons: Set, Get

2. Make any changes required and click **Set**.

Transferring Files

To transfer graphics/fonts/firmware files to the printer:

1. Connect the printer to your computer and turn on the printer.
2. Double click on the Printer Management Utility icon to open it.

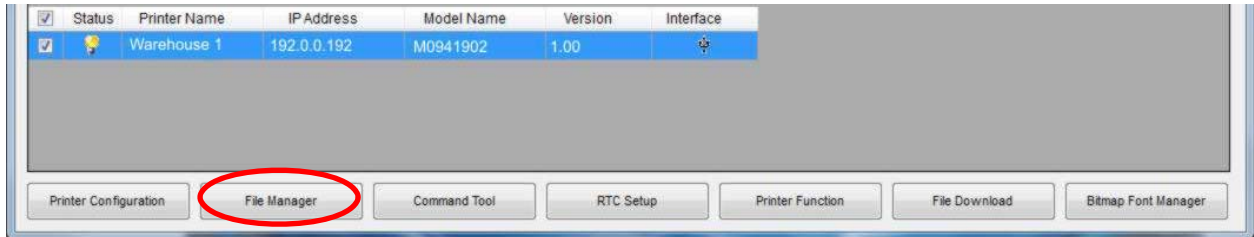

3. Select the printer.
4. Click **File Manager**.
5. Select the File Type to download: BMP, PCX, TrueType font, Bitmap font, Firmware file, etc.
6. Click **Browse** to navigate to the file.
7. Click **Open**.
8. Click **Download** to send the file to the printer.

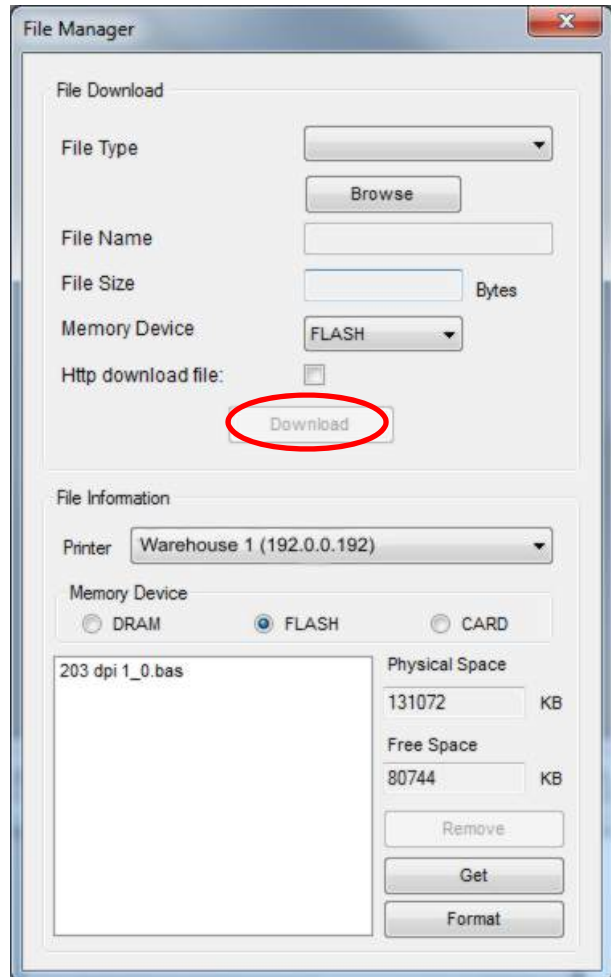

MENU STRUCTURE



Use the navigation button then press **Select** when you see the option you need.

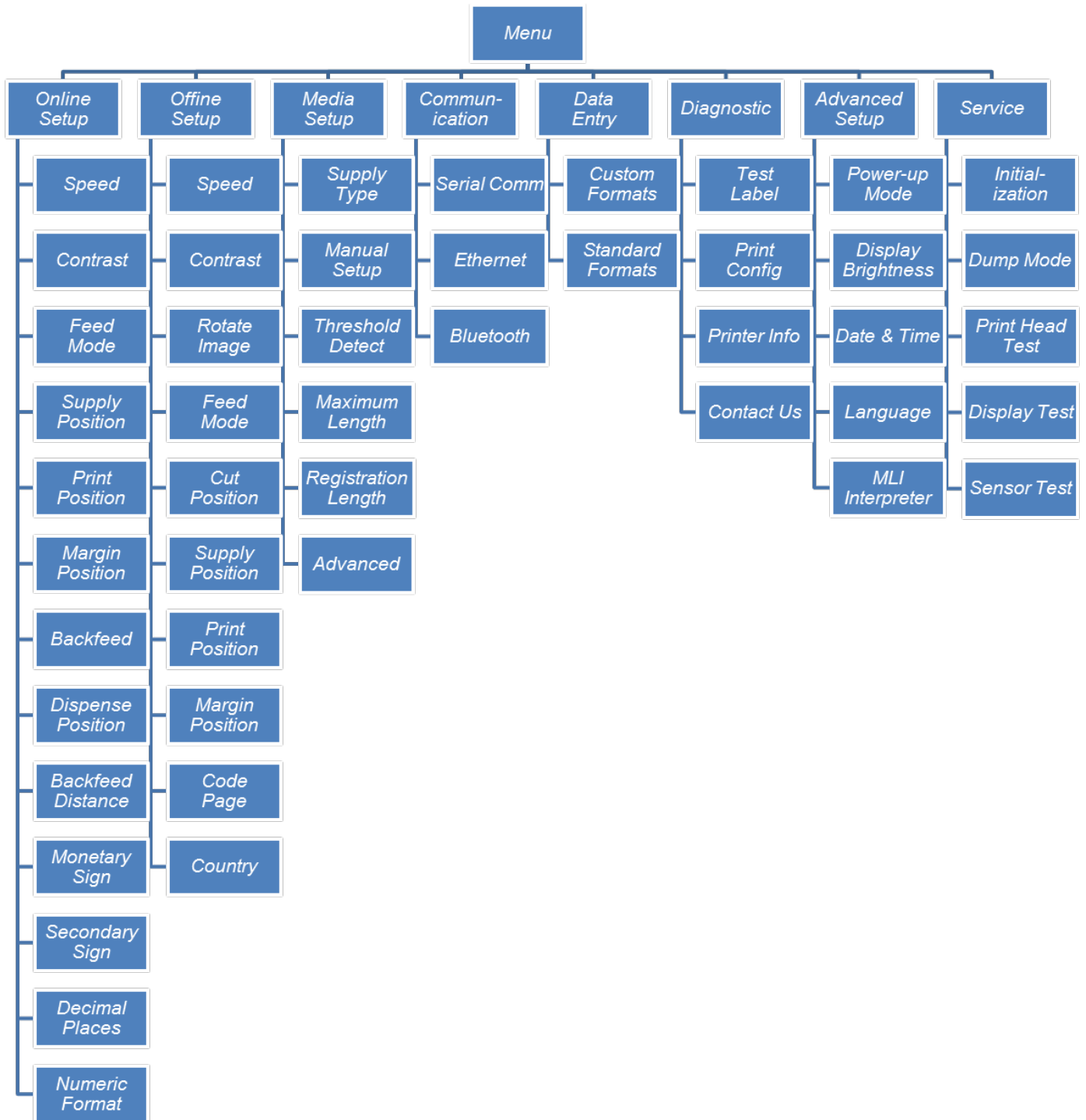

AMERICAS

170 Monarch Lane
Miamisburg, OH 45342
937 865 2123 (direct)
Tel +800 543 6650
(8:00 a.m. – 6:30 p.m., EDT)
Fax +937 865 6663

ASIA

No. 7 Chun Ying Street
Tseung Kwan O Industrial Estate
New Territories, Hong Kong
Tel +852 2372 3169
Fax +852 2995 0014

WESTERN EUROPE

1 Thomas Road
Wooburn Green
Bucks HP10 0PE
Tel +(44) 1628 859500
Fax +(44) 1628 859567

ASIA PACIFIC**NEW SOUTH WALES**

61 Vore Street
Silverwater NSW 2128
Tel +(02) 9647 1833
Fax +(02) 9647 1914
Toll free (Outside Sydney only)



Printer
Solutions