

# PRINthead INSTRUCTIONS

The printhead is sensitive to static electricity, which can damage the printhead or reduce its life. Ground yourself by touching metal, such as the printer's metal base, before touching the printhead.

## IMPORTANT

If your Avery Dennison® ADTP1/ADTP2 printer uses a **203dpi printhead**, you must update the firmware and set the Printhead Type.

Update your printer firmware to Version 3.11 or greater. If you cannot update your firmware, adjust Print Contrast to achieve optimal print quality or call Technical Support.

 Data streams may override settings made on the printer.

Compare your new printhead with this photo:

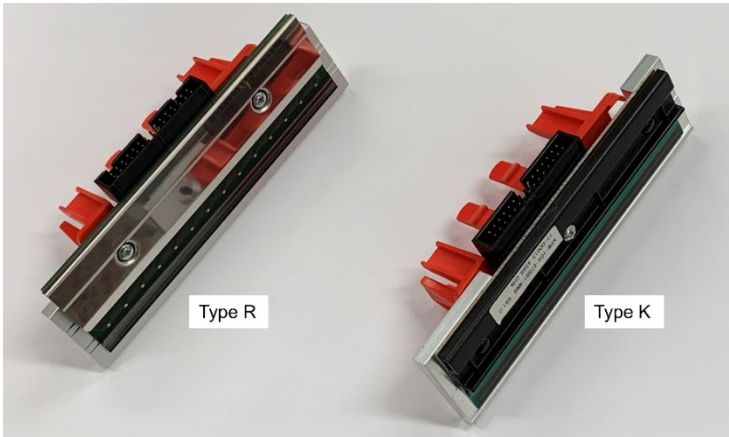

 Type R has all metal construction and attaches with two screws; Type K has black plastic construction and attaches with one screw.

## Setting the Printhead Type

---

To set the Printhead Type:

1. From the Main Menu select **TLABEL**.
2. Press **←**. You see **Printhead Type**.
3. Press **SELECT**.
4. Press **←** or **→** until you see the Printhead Type you need (Type R or Type K), then press **SET**.
5. Press **BACK** until you see “Ready,” then press **SELECT**.

## Replacing the Printhead

---

To replace the printhead:

1. **Turn off the printer.**
2. Open the cover.
3. Unlock the printhead by turning the retaining latch.
4. Press forward and down on the two latches on top of the printhead assembly as shown. The printhead will drop out.

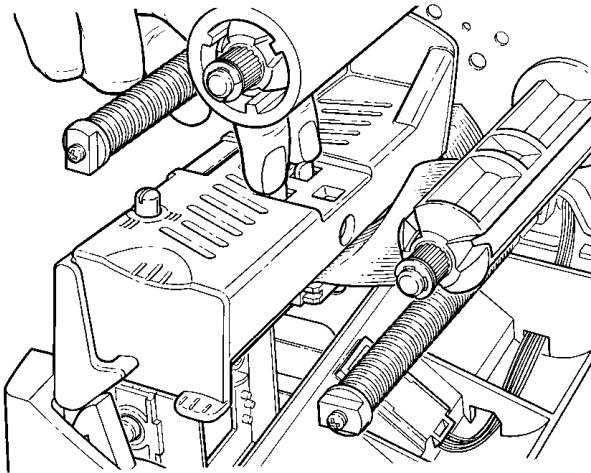

5. Lift the printhead assembly using the printhead tab and push back until the printhead assembly clicks into place.

6. Carefully unplug the cable from the printhead as shown. The printhead is sensitive to static electricity, which can damage the printhead or reduce its life. Ground yourself by touching some metal, such as the printer's metal base, before touching the printhead.

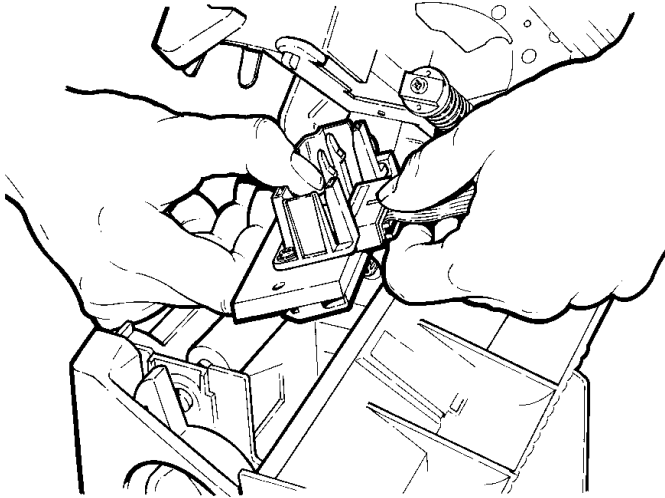

7. Carefully plug the cable into the new printhead.
8. Align the new printhead with the tabs.

9. Snap the printhead into place.

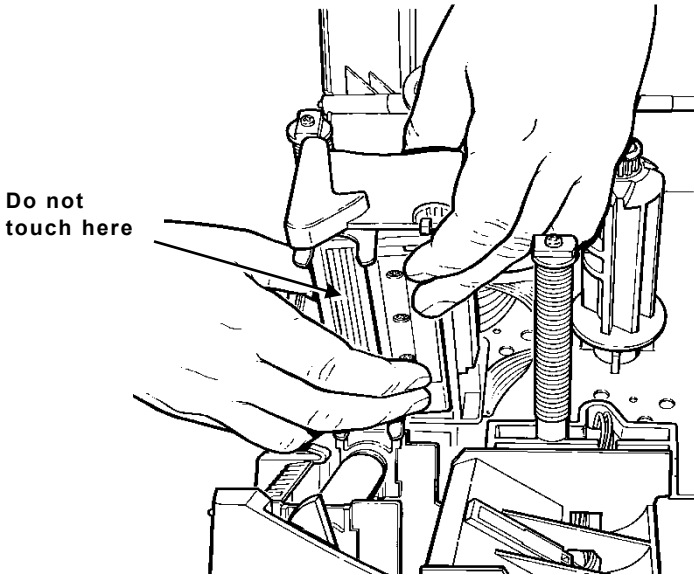

 Make sure the printhead cable does not touch the ribbon roll.

10. Clean the new printhead with a cotton swab dipped in isopropyl alcohol to remove any salt or oil left from handling.
11. Let the printhead dry and reload your supplies.
12. Push down on the printhead assembly to lock it in place.
13. Close the cover.
14. Turn on the printer and press **Feed/Cut** to position the supply.